

TENDER 5-RE
ORIGINAL B-11A TENDER

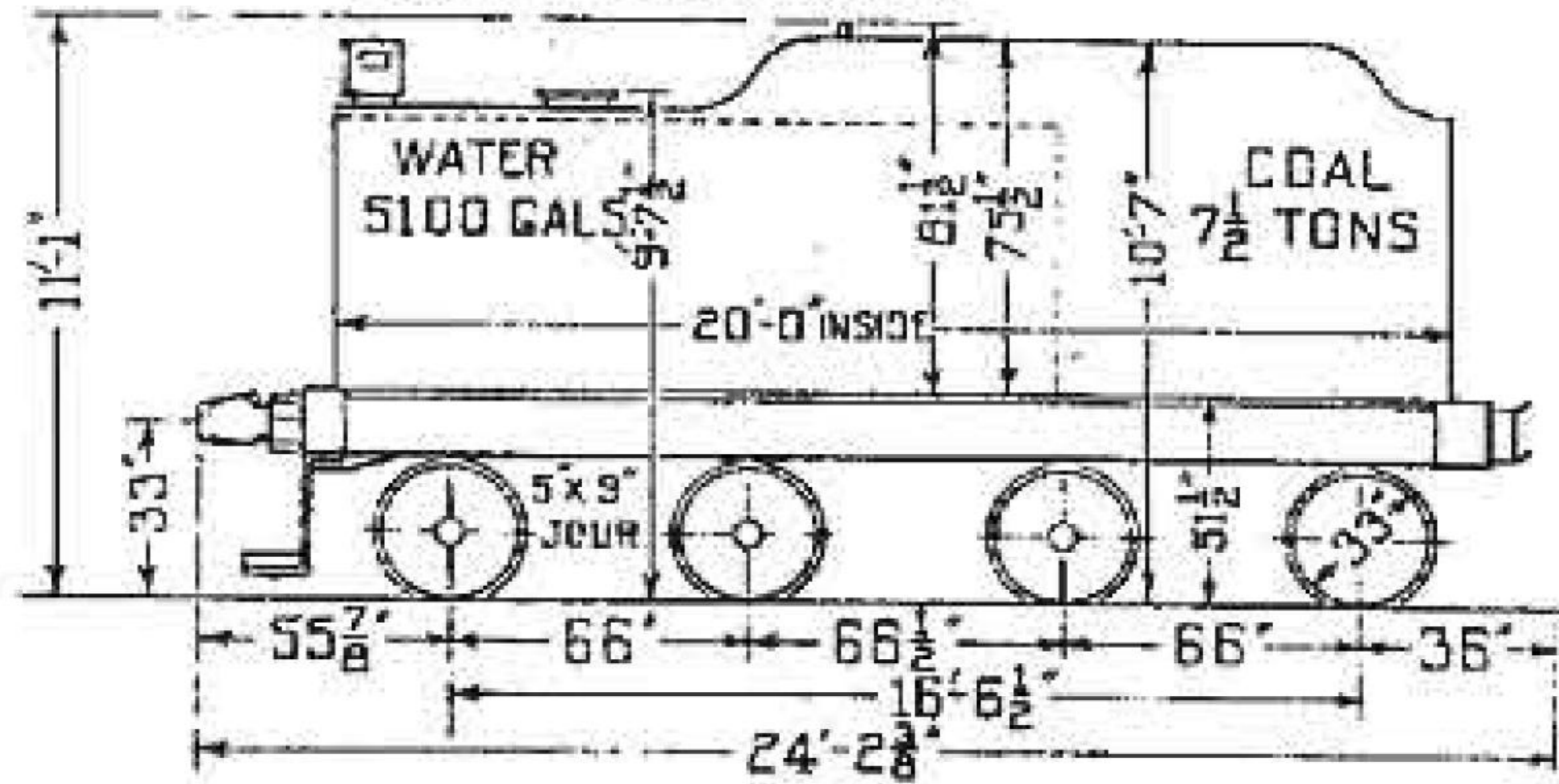

TENDER 5-RF IS ORIGINAL B-110 TENDER

TENDER 5-RF

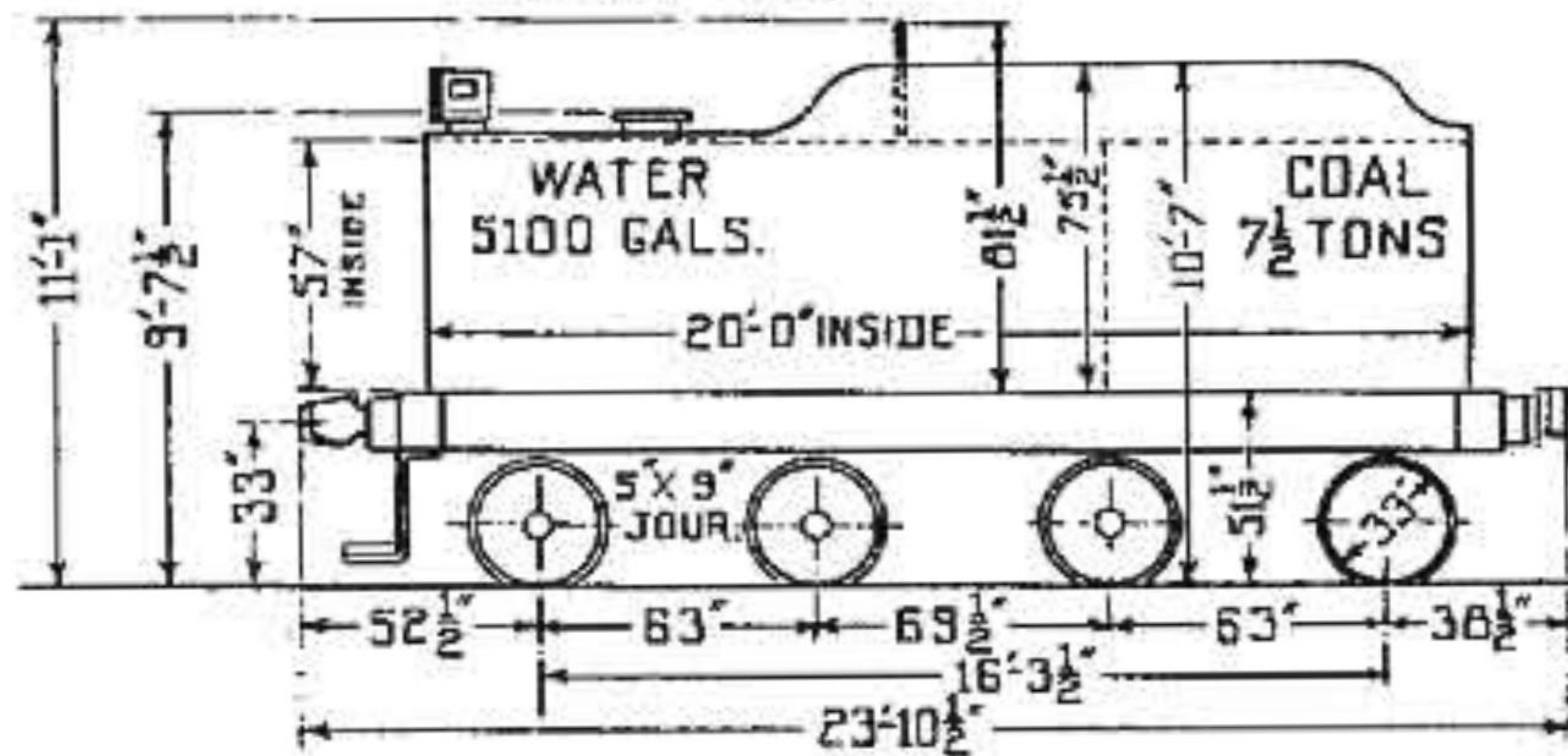

TENDER-5-RC

COAL 10 TONS

WATER 3500 GALS.

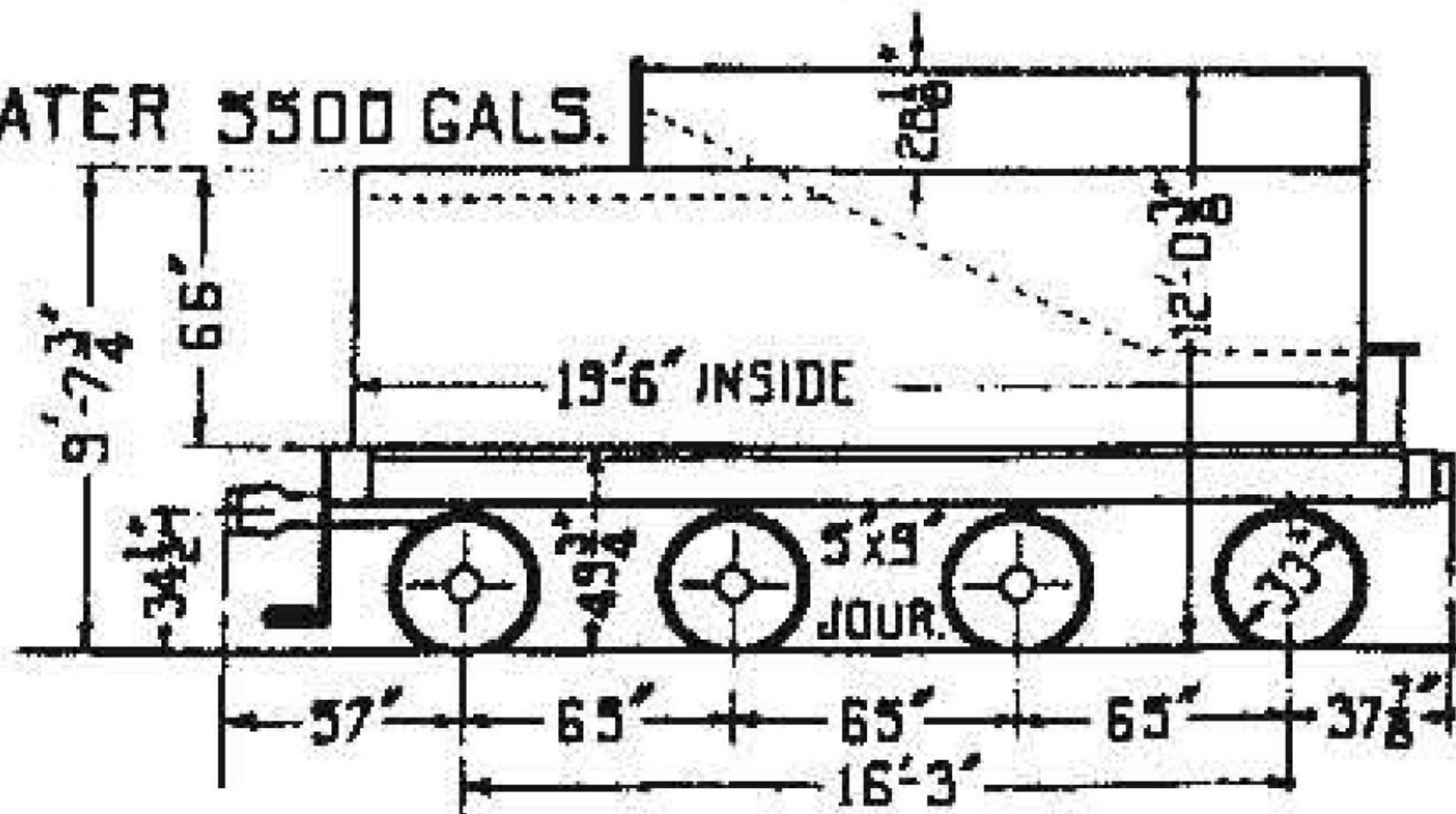

TENDER 6-RH IS ORIGINAL B-11B, B-11C TENDER

TENDER 6-RH

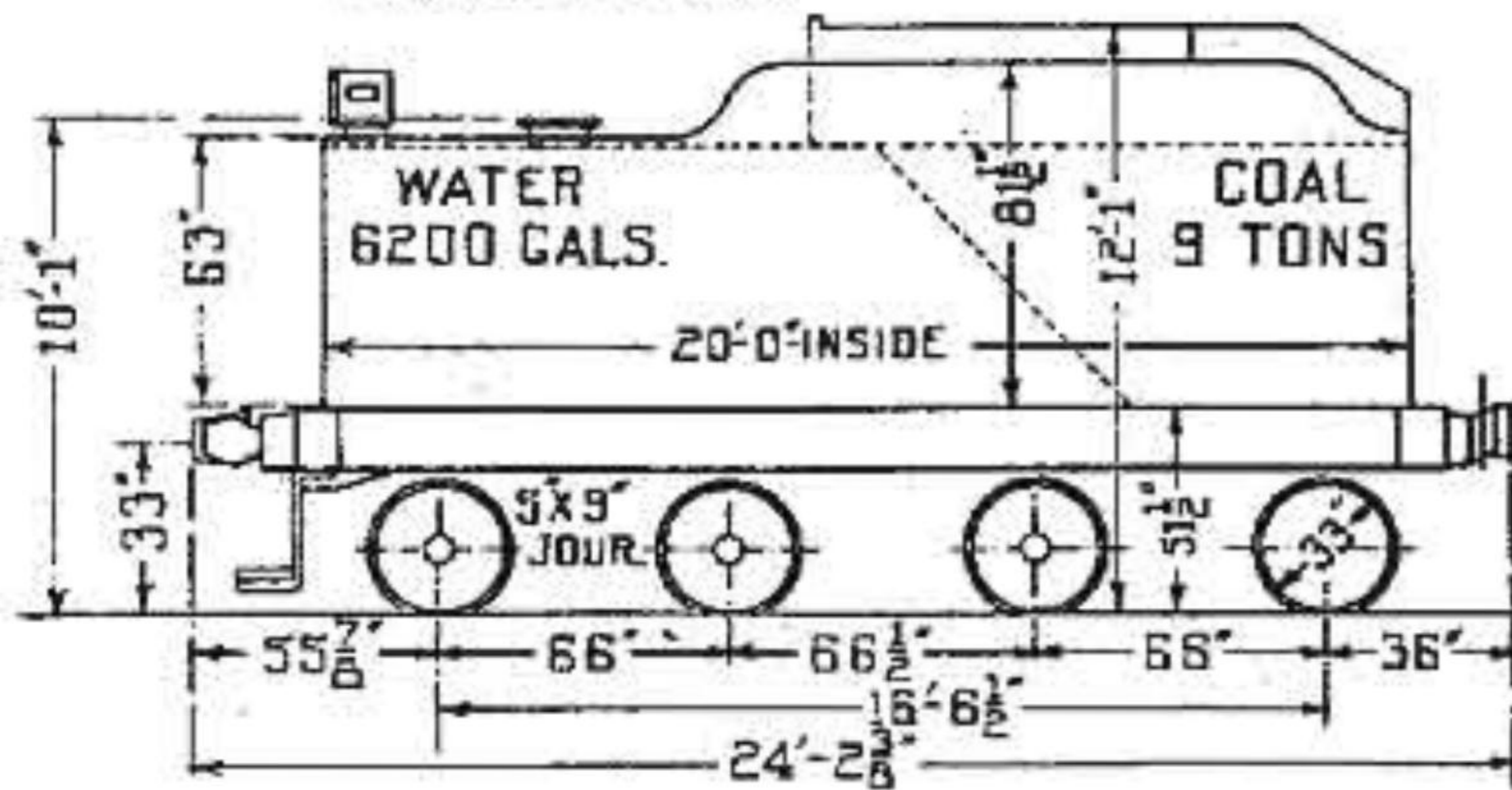

TENDER 6-RJ
 ORIGINAL 2-10 TENDER LENGTHENED

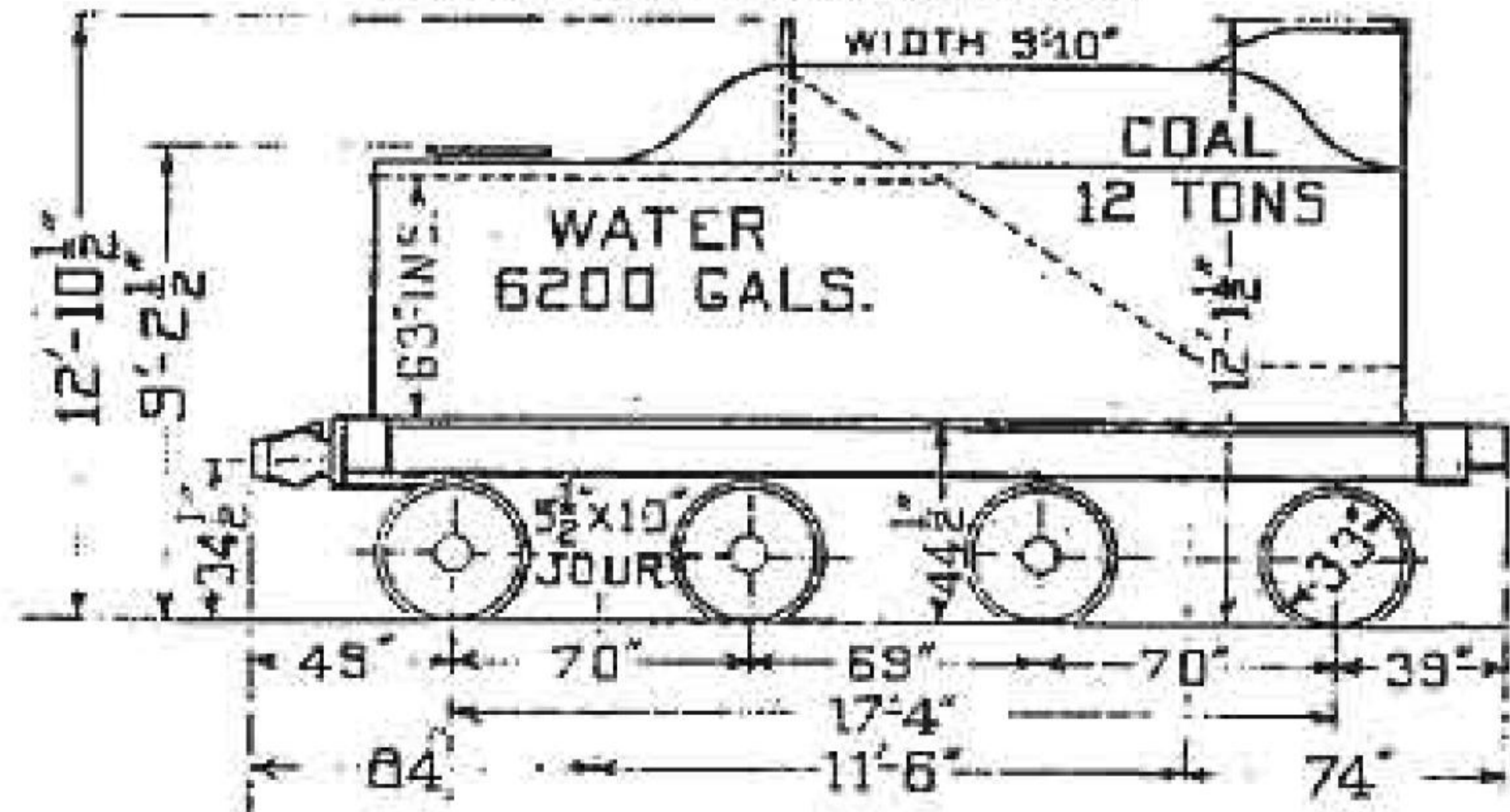

TENDER B-RN

WATER 5500 GALS

COAL 14 TONS

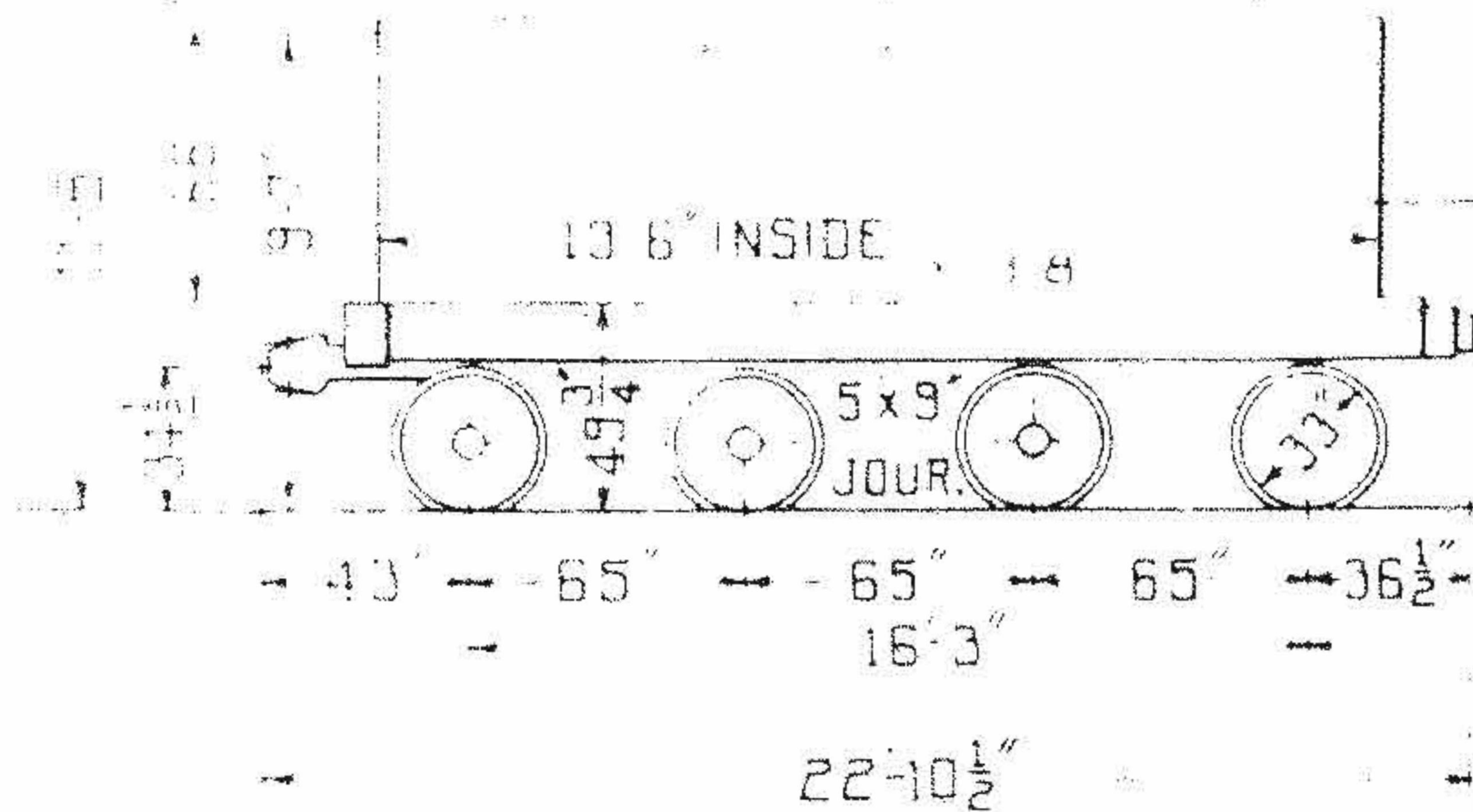

TENDER- 6-R-SRR
 6-RS IS ORIGINAL B-12 TENDER

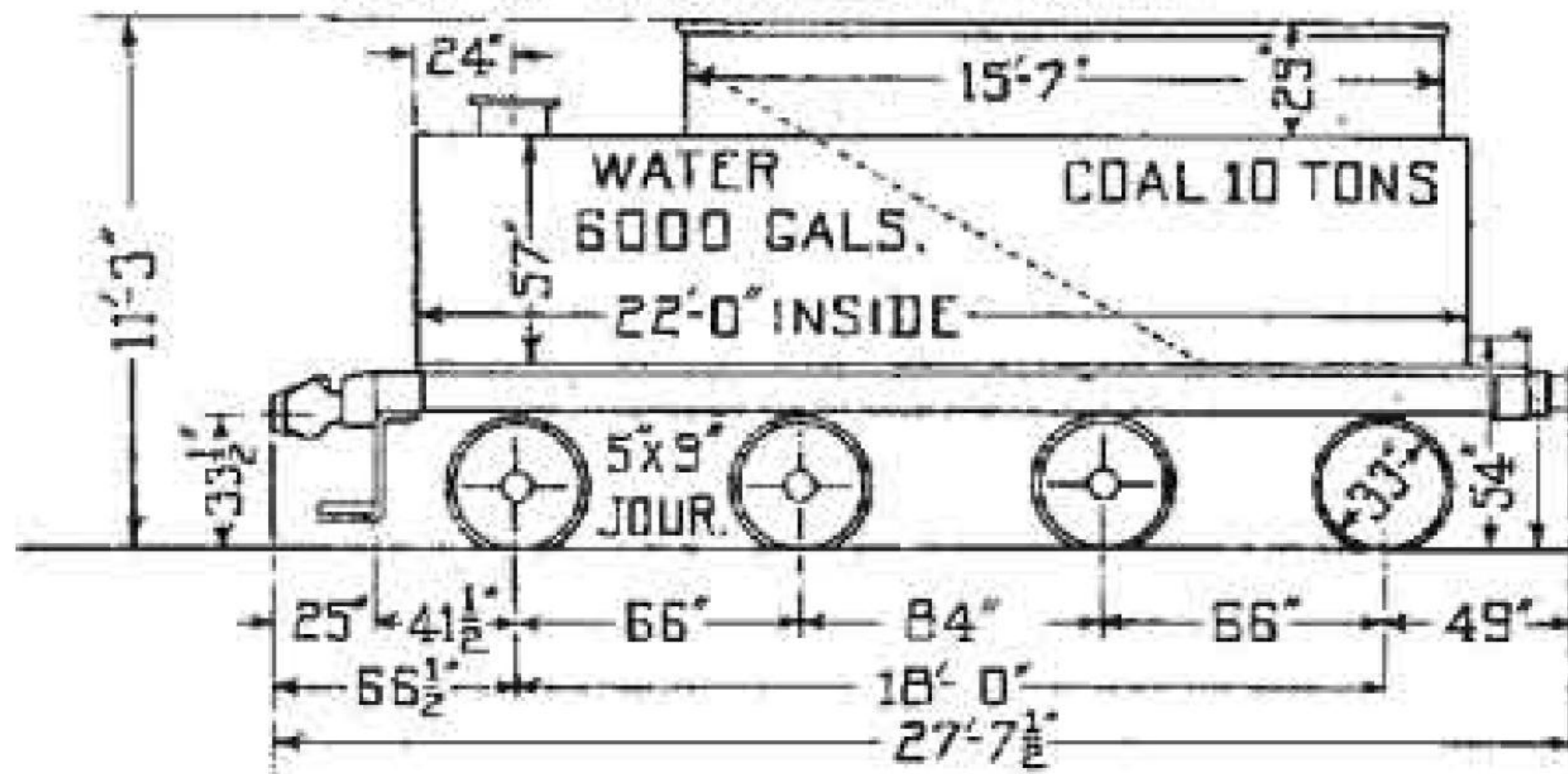

TENDER 7-RK IS ORIGINAL G7, G8, G9, G10A TENDER

TENDER-7-RK

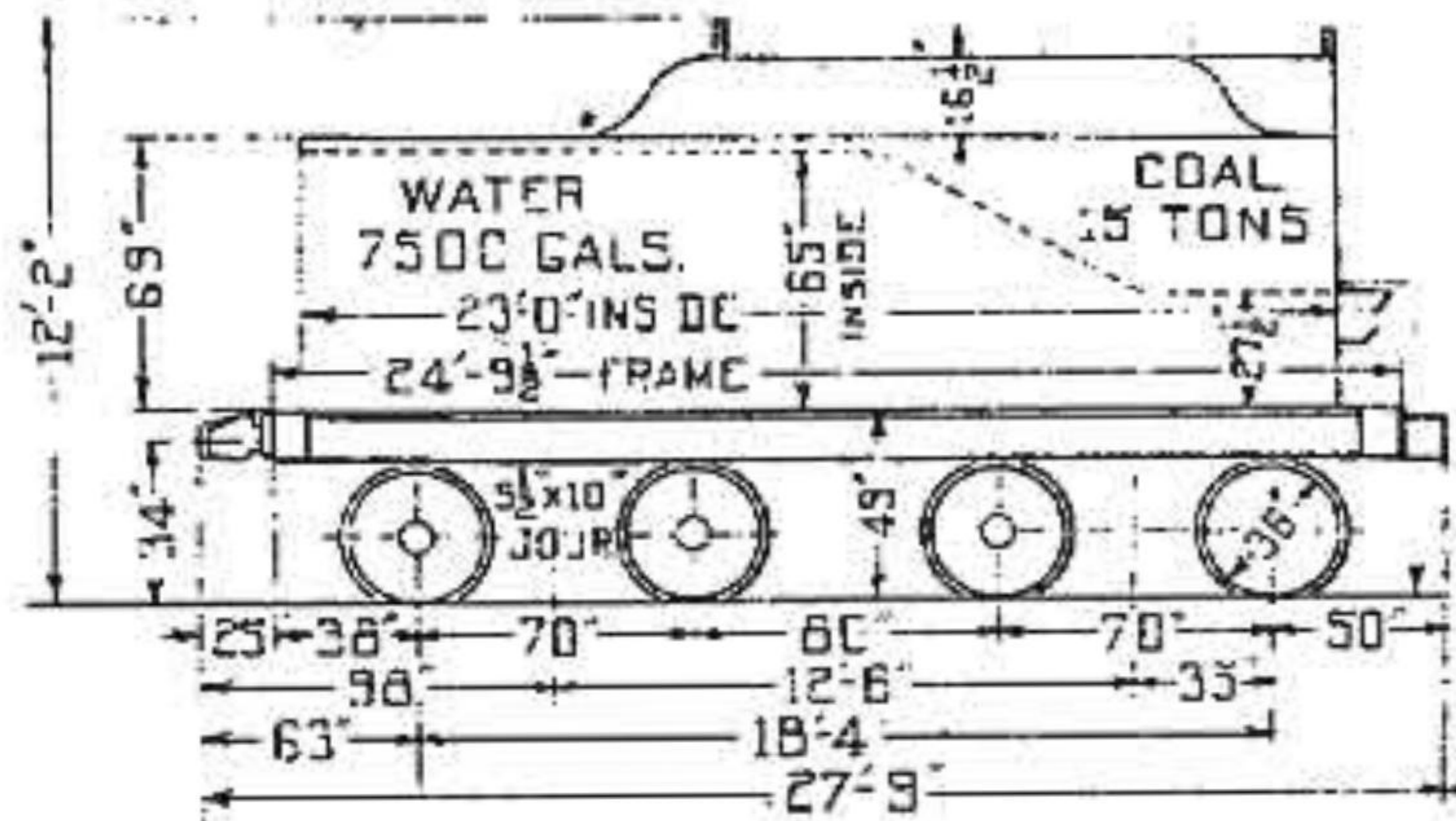

TENDER B-RH IS FROM DISMANTLED CLASS T - LENGTHENED

TENDER-B-RHA

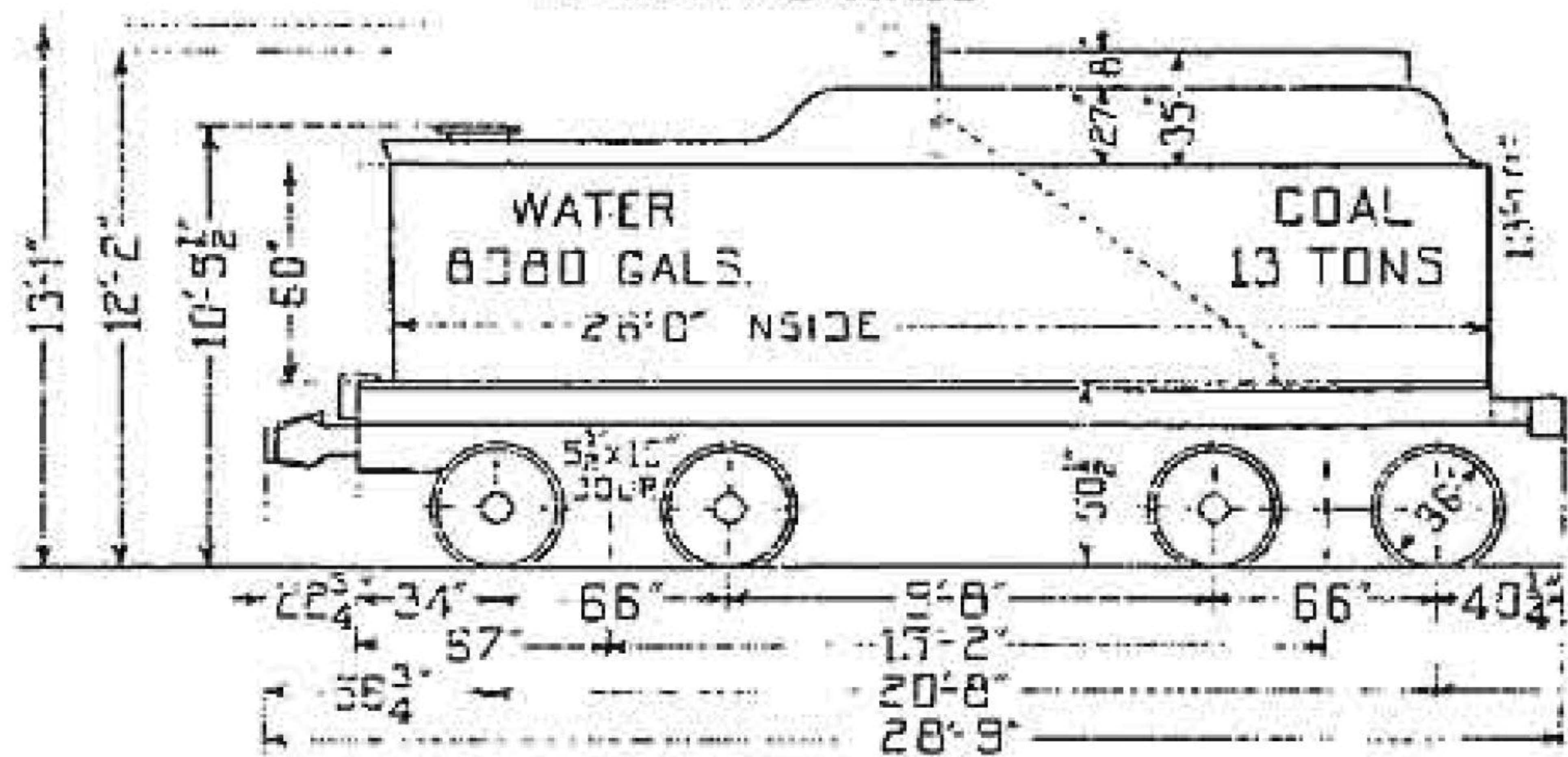

TENDER B-RJ IS ORIGINAL G.6V. 15V. 15W, WITH BUILT UP FRAME

TENDER B-RJ

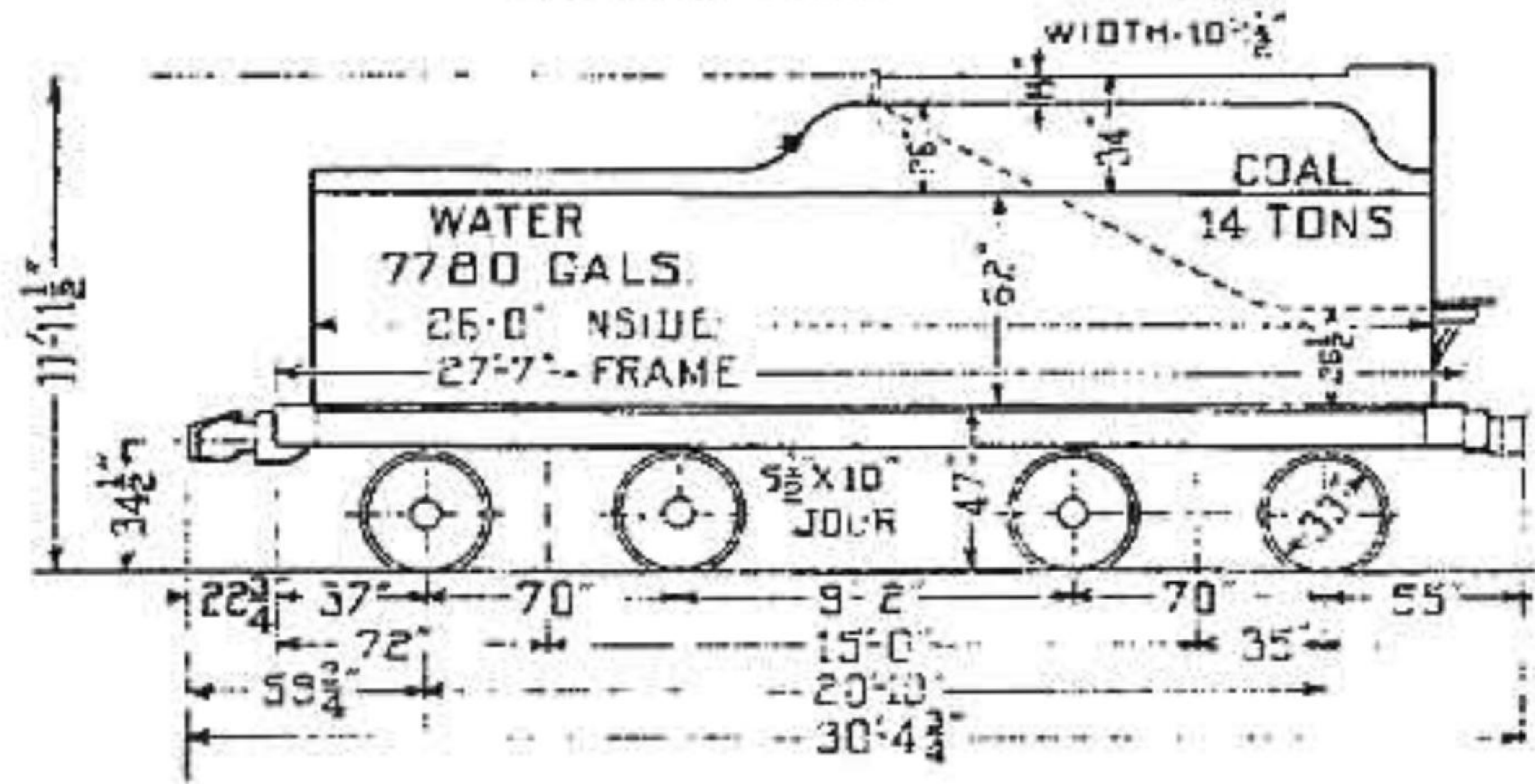

TENDER B-RL

ORIGINAL H-5A H-5B TENDER

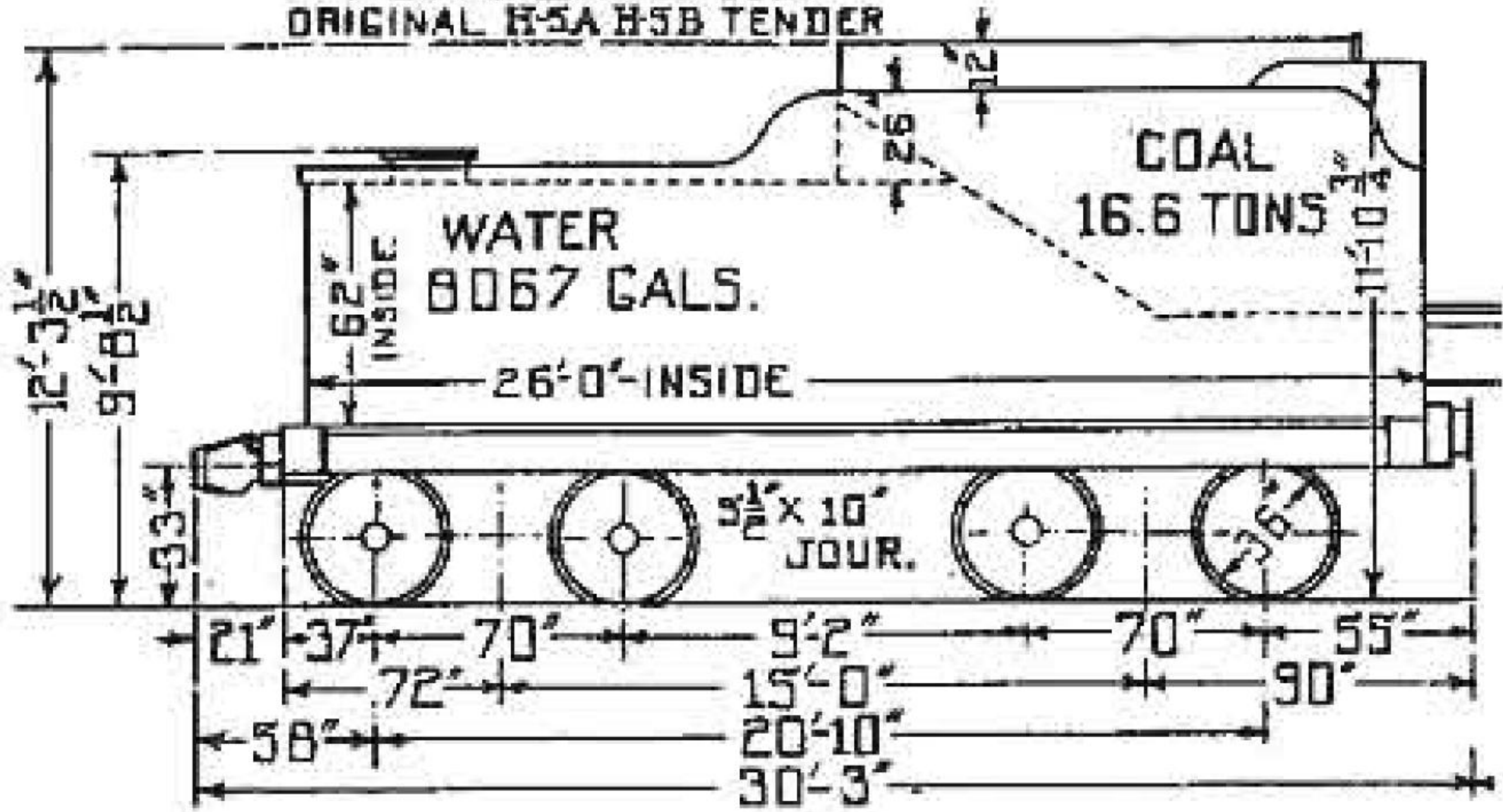

TENDER B-RS

TENDER B-RS IS ORIGINAL B-RL WITH COAL
CELLAR SET BACK IN FOR VISIBILITY

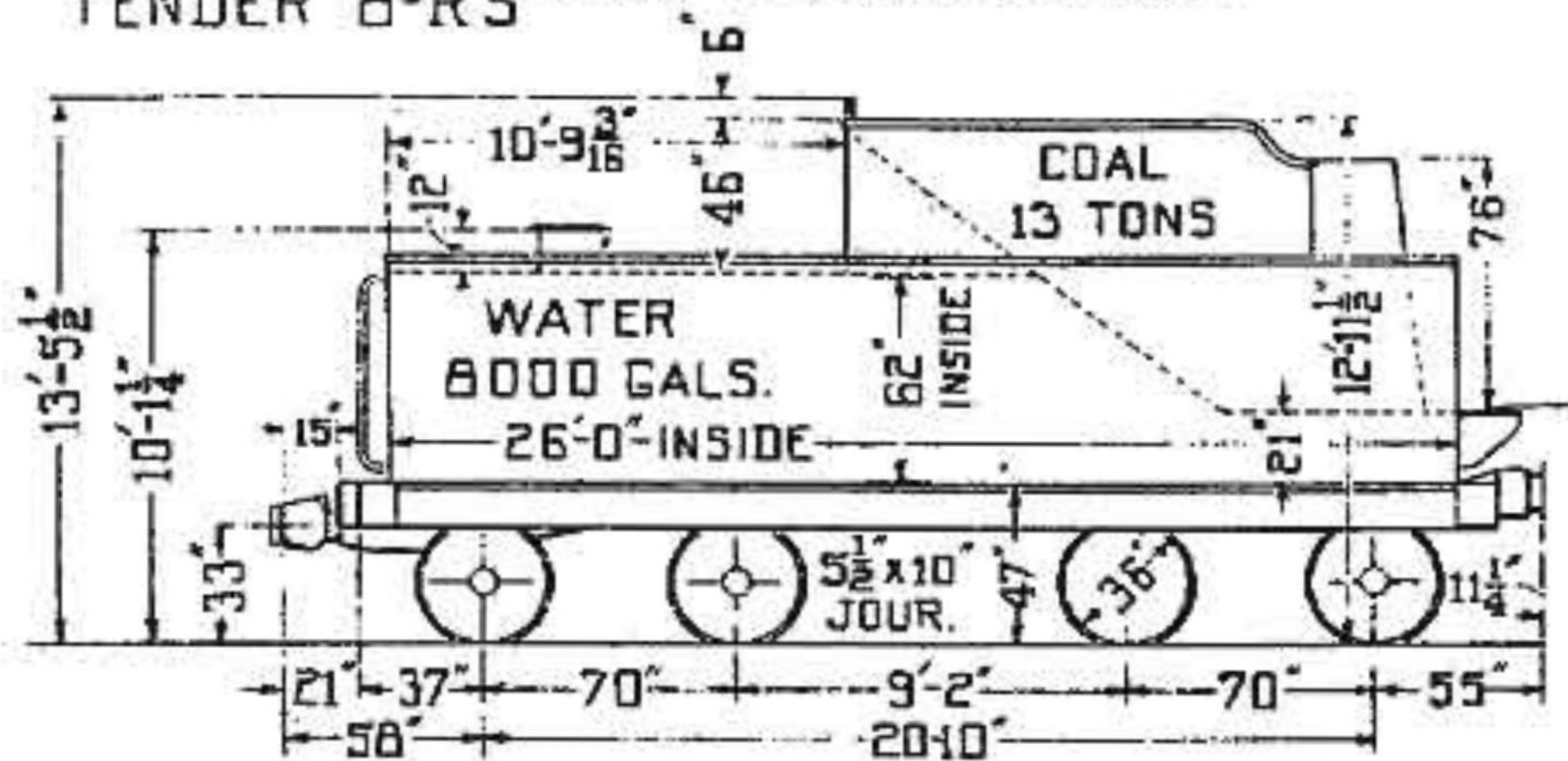

TENDER B-RX

TENDER B-RX IS ORIGINAL

B-RL WITH SIDES OF COAL SPACE MOVED INWARD FOR VISIBILITY.

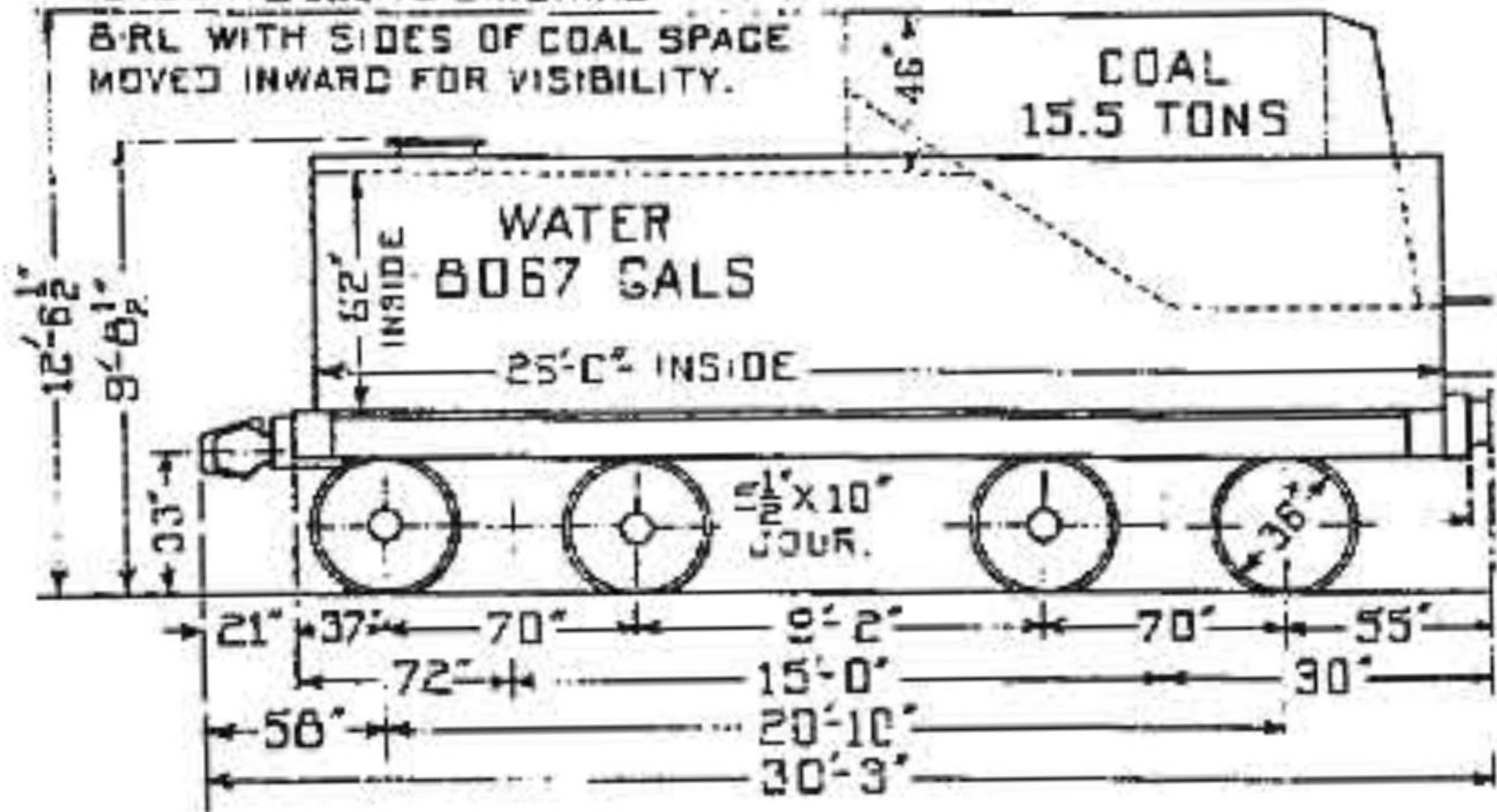

NOTE-1: TENDER B-RY IS CONVERTED FROM P.R.C. WITH COAL COLLAR SET BACK IN, IN MANNER AS SHOWN ON PAGE 27-B, FOR SWITCHING SERVICE.

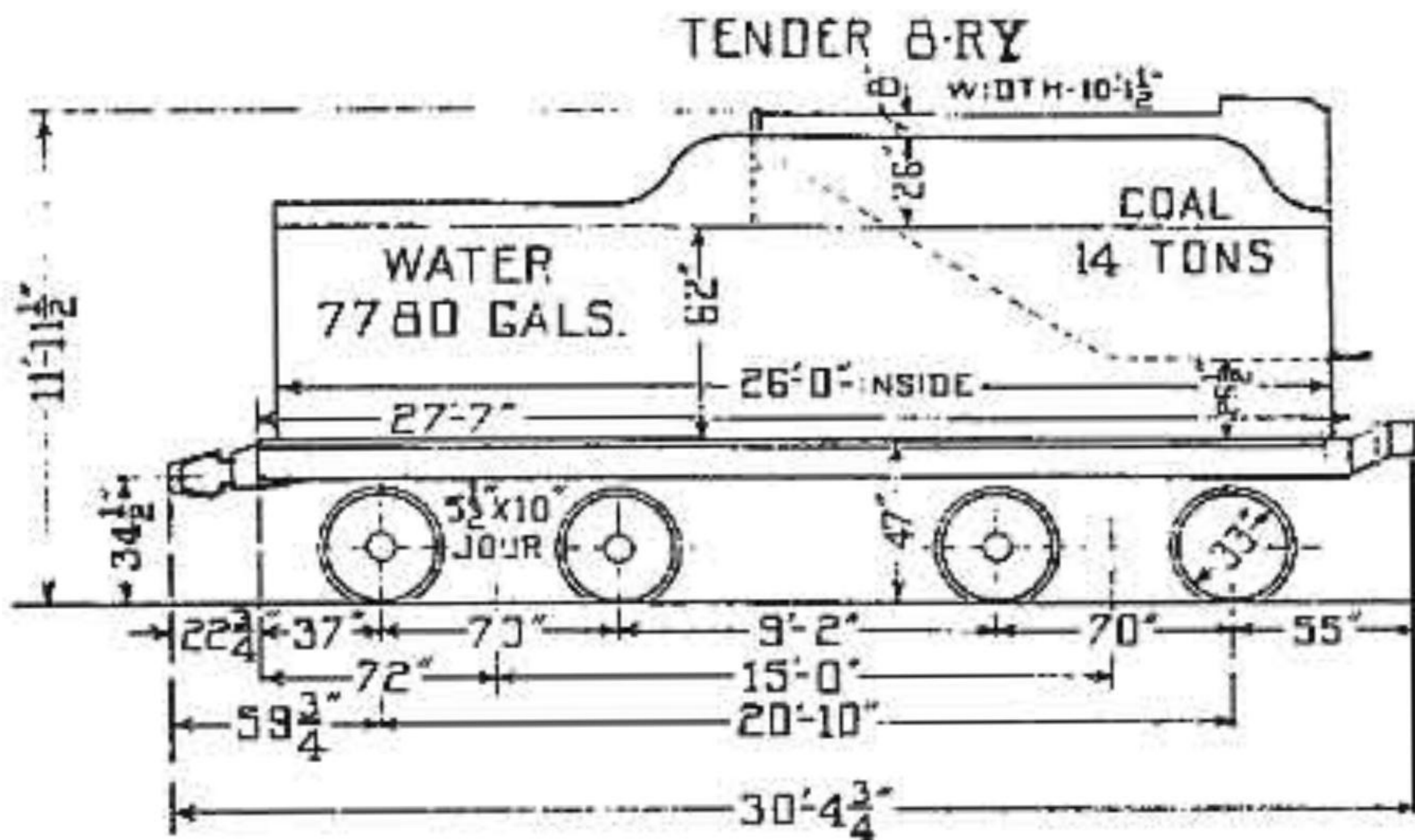

TENDER 9-RR IS ORIGINAL G-7, B, S, 10A WITH REAR TRUCK AND LENGTHENED TANK AND WITH H6 FRONT TRUCK AND TENDER FRAME.

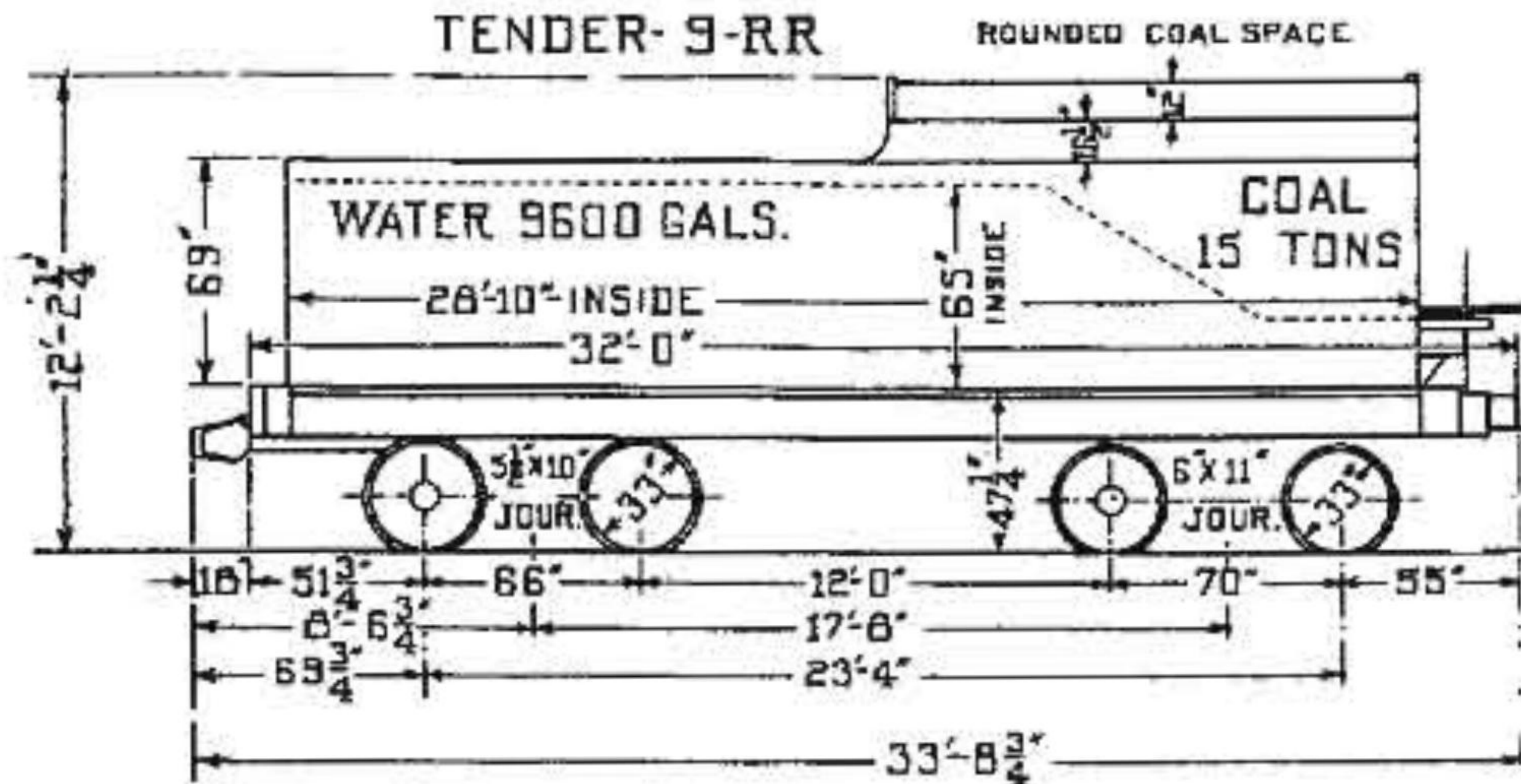

9-RR IS ORIGINAL 6-7, 8, 9, 10A WITH REAR TRUCK AND LENGTHENED AND WITH H8 FRONT TRUCK AND TENDER FRAME.

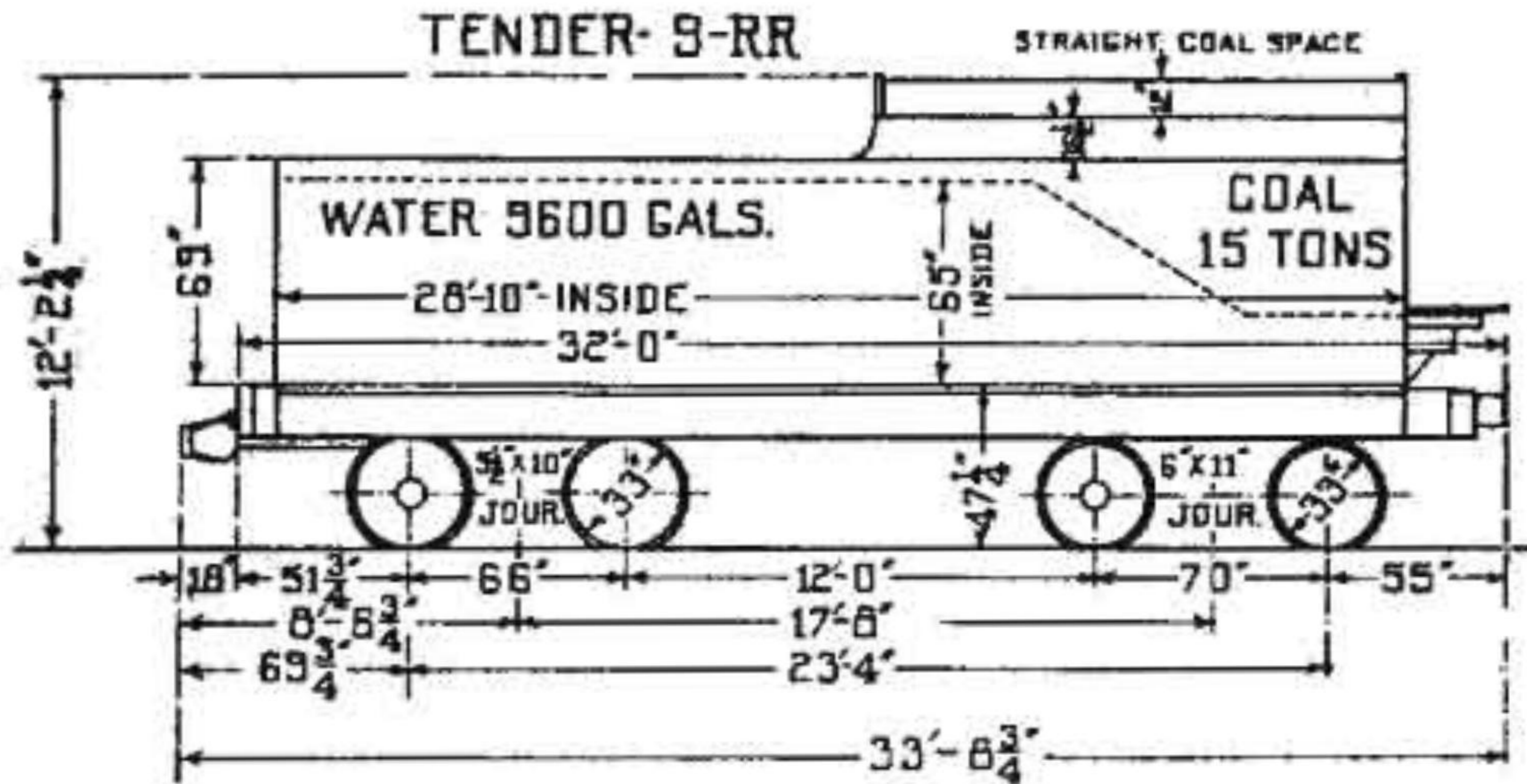

TENDER 10-RE

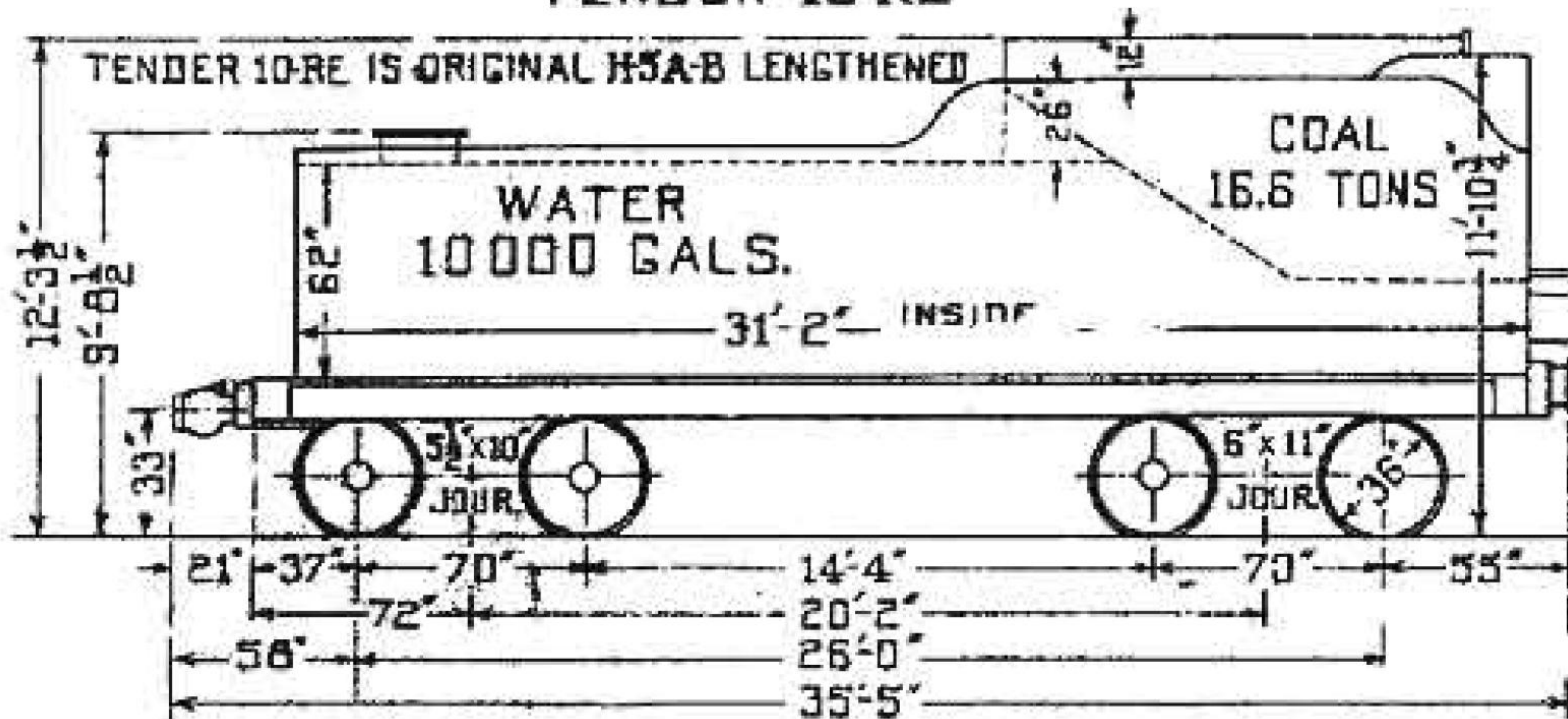

TENDER 10-RF IS ORIGINAL H-6A H-60 TENDER

TENDER 10-RF

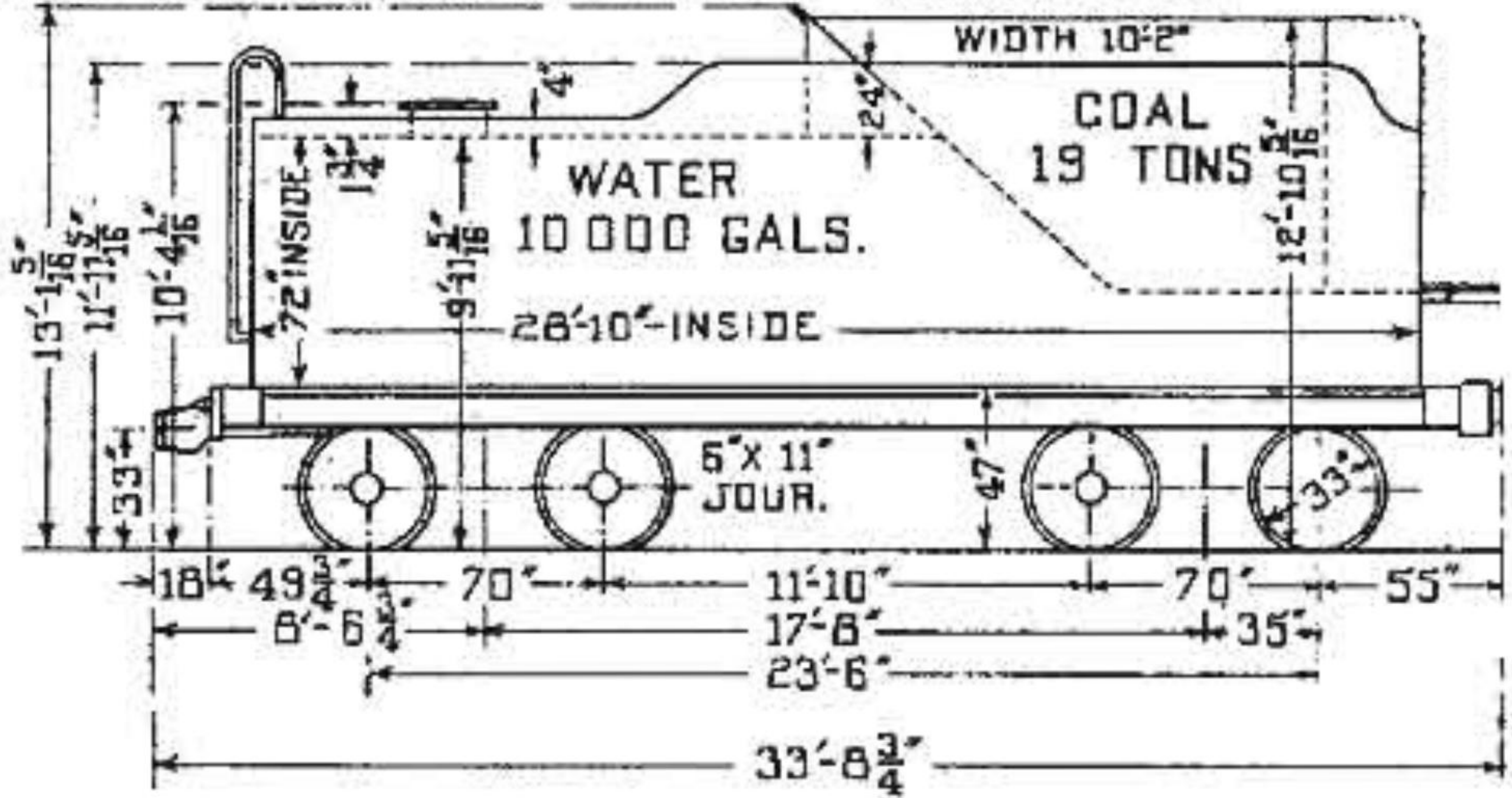

TENDER 10-RG

TENDER 12-RC AS ON PAGE 32-A NOW ON ENG. 611

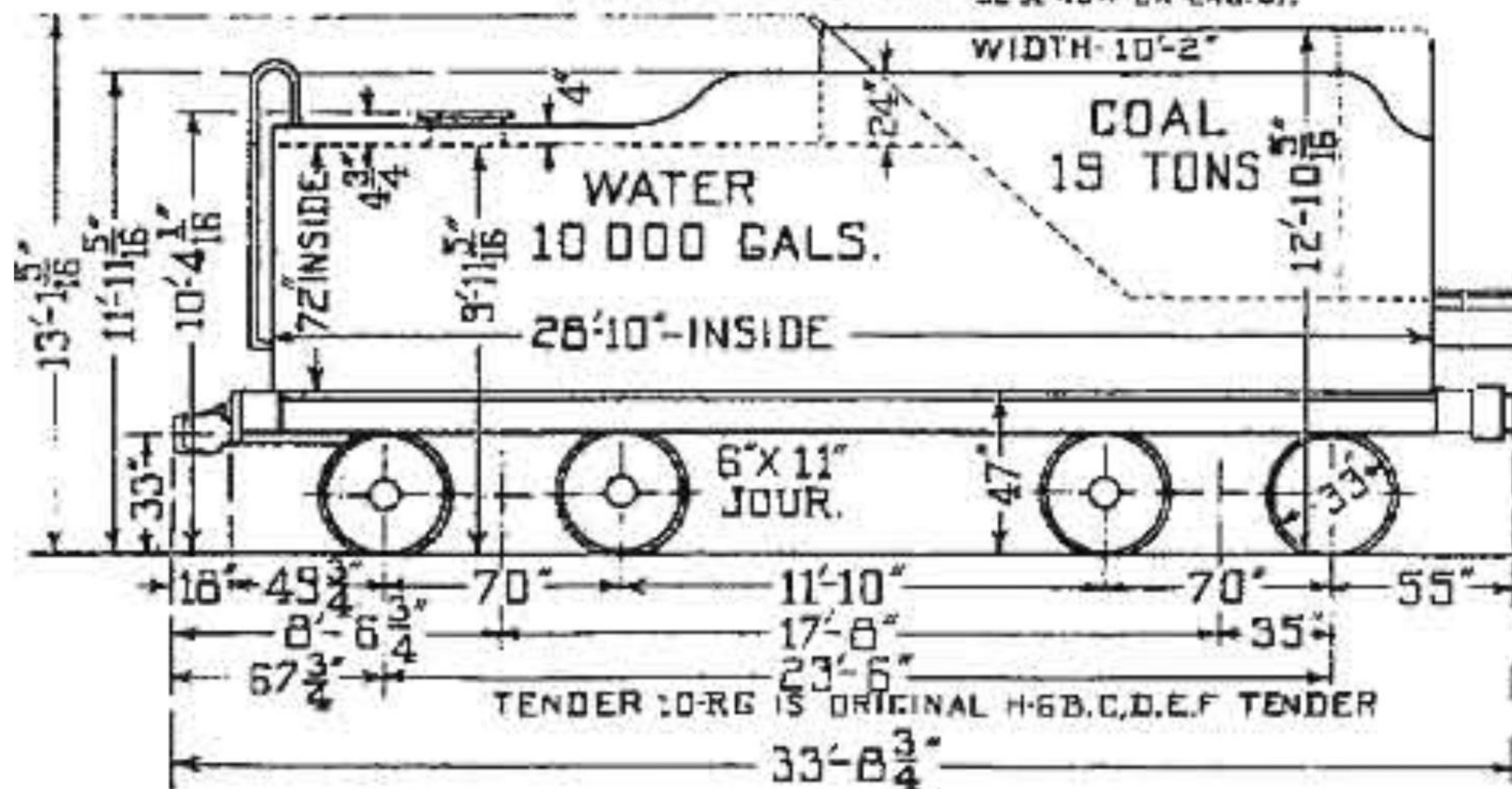

TENDER 11-RB IS ORIGINAL L1-A, L1B, TANK AND FRAME WITH H-6 TRUCKS.

TENDER 11-RB

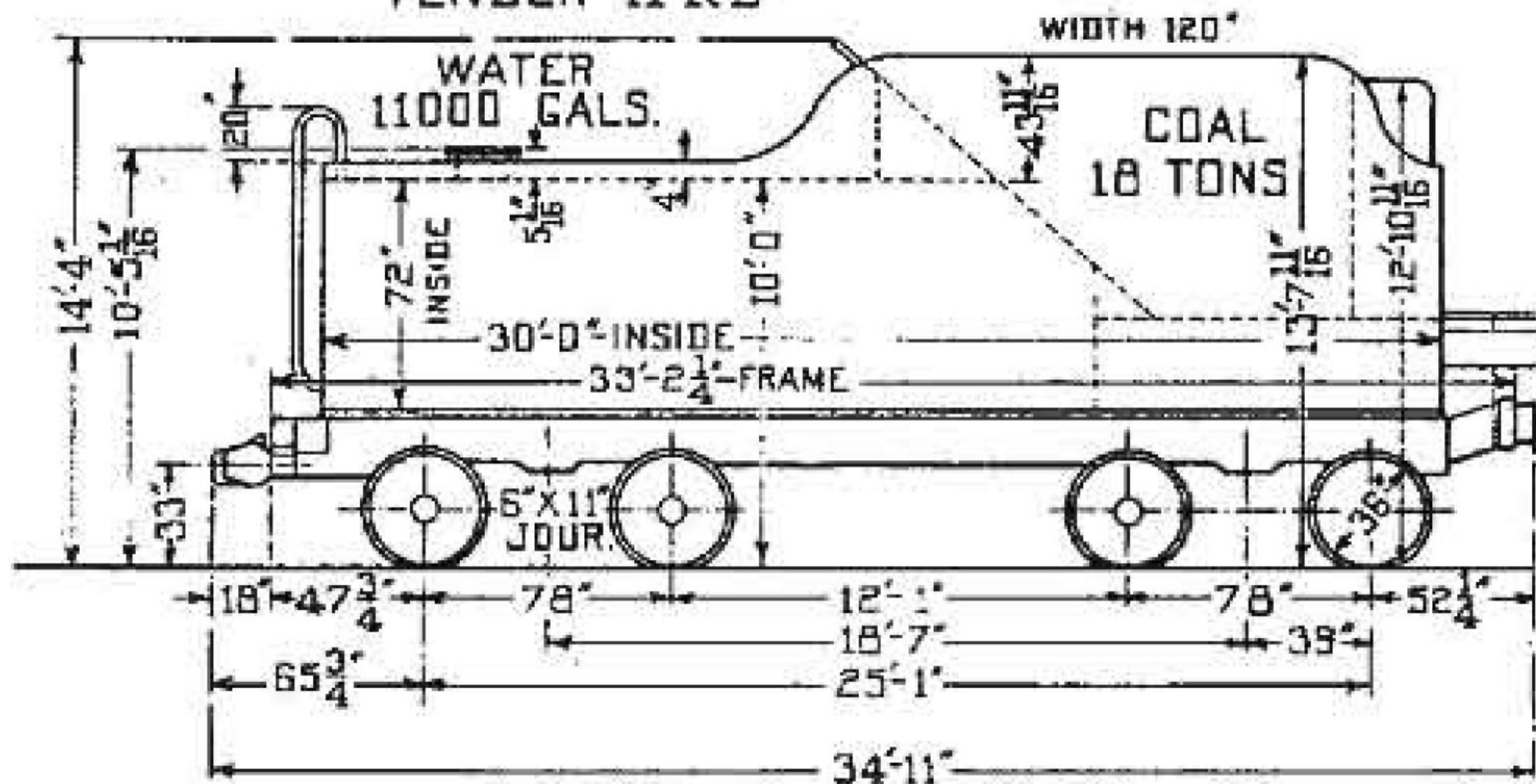

TENDER 12-RC IS ORIGINAL H-6 LENGTHENED 54"

TENDER 12-RC

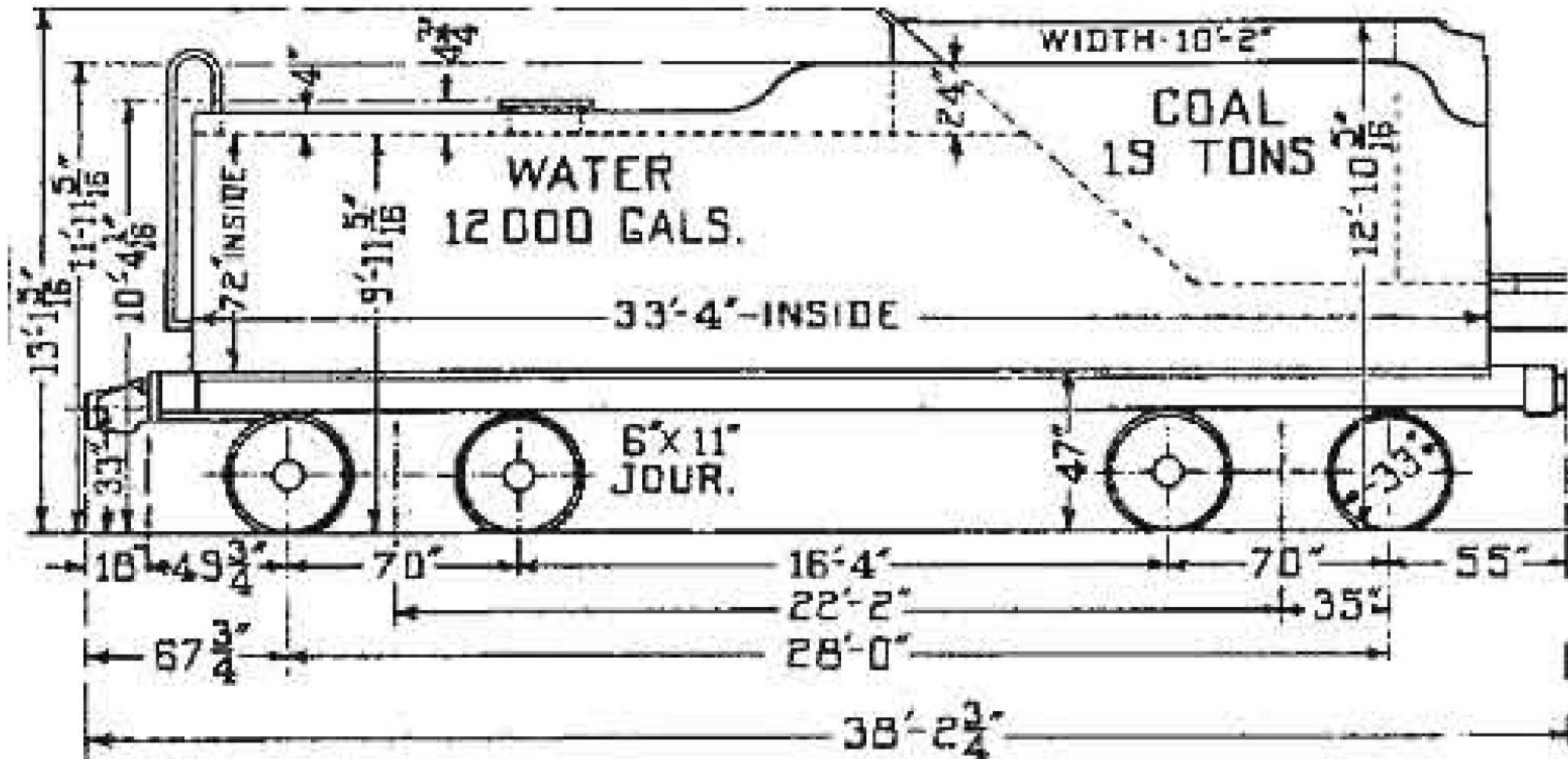

TENDER 12-RD

WIDTH-10'-2"

WATER
12 000 GALS.

COAL
20 TONS

33'-4" - INSIDE

5' X 11"
JOUR.

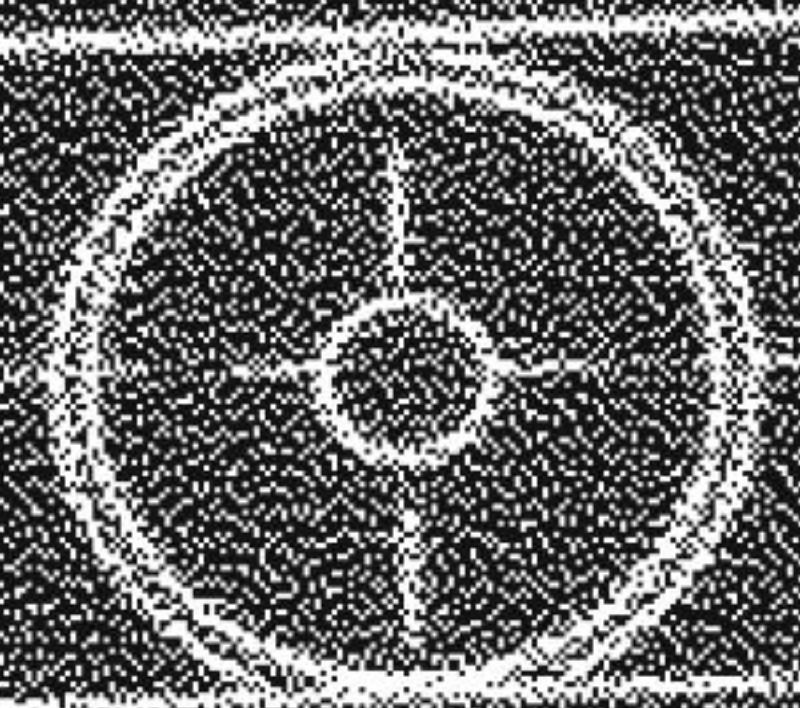
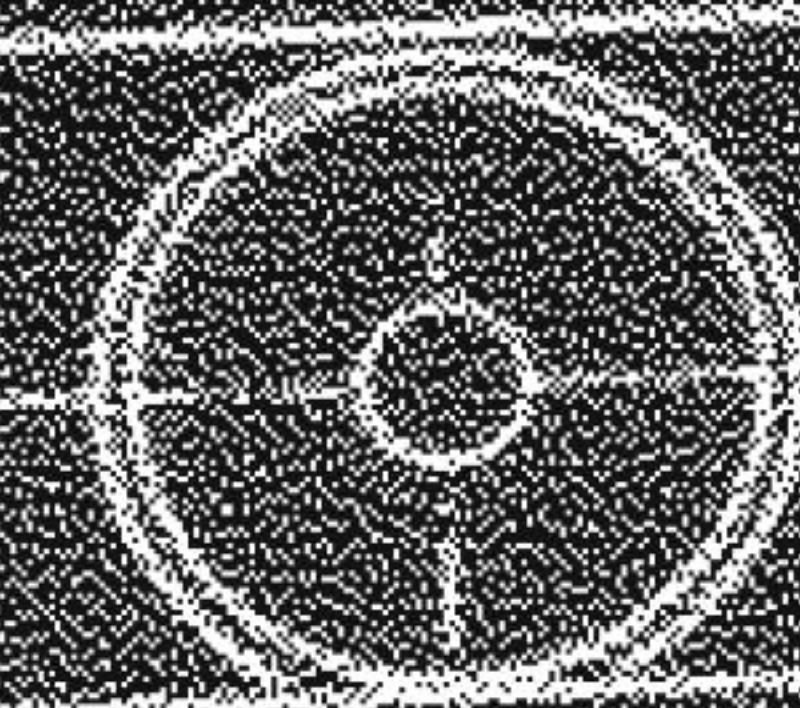

18'-4 1/2"
5'-3 3/4"

78"

15'-0"
22'-2"
28'-0"
38'-2 1/4"

78"

39"

51"

10'-8"

10'-0"

10'-2"

10'-0"

10'-0"

10'-0"

TENDER 13-RA IS ORIGINAL H-6B, H-6F, (OLD 12-RC) LENGTHENED 96"
 AND WITH NEW TRUCKS

TENDER 13-RA

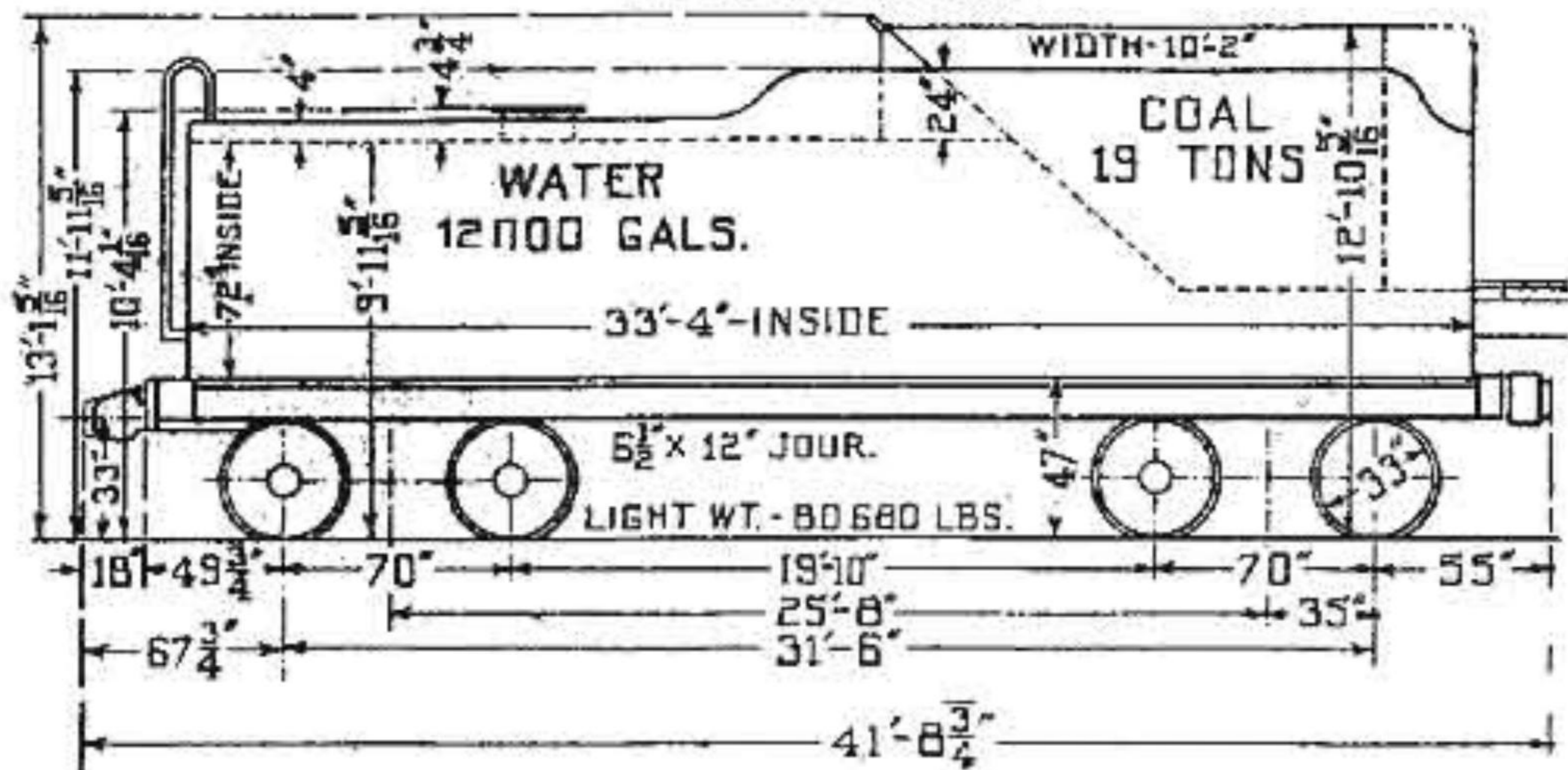

TENDERS 16-RA, 16-RB, 16-RC

WATER 16 500 GAL.

WIDTH OVER BEADINGS 10'-2"

INSIDE WIDTH 120"

COAL
19 TONS

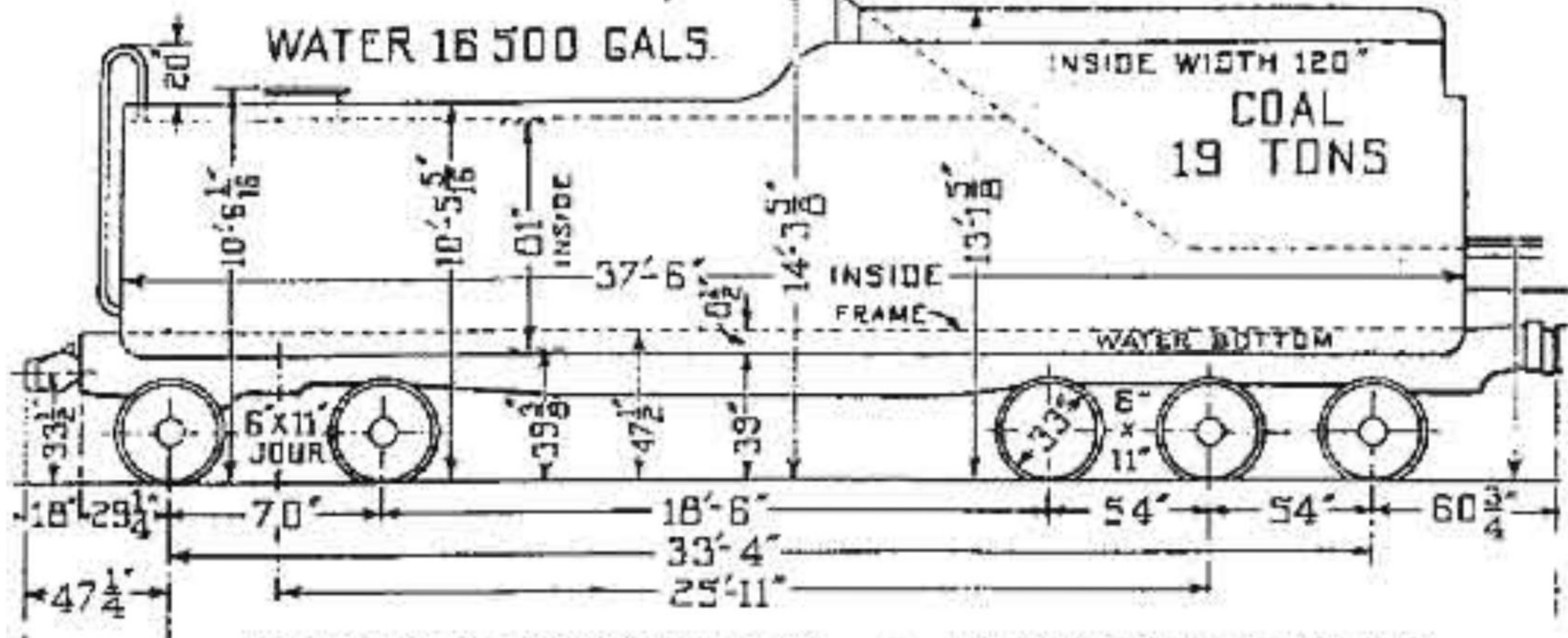

TENDERS 16-BA, B, C ARE REBUILT H-B 42'-4" TANK AND REAR TRUCKS WITH
 NEW FRAMES AND NEW 6 WHEEL TRUCKS - BUCKEYE ON 16-RA-RC, AND
 G.S.C. CORP. ON 16-RB TENDERS

TENDER 16-RC IS REBUILT HIG TANK AND REAR TRUCKS, WITH NEW FRAME AND NEW 6 WHEEL BUCKEYE FRONT TRUCK, REBUILT IN 1937.

TENDER 16-RC

WATER 16 500 GALS.

WIDTH OVER BEADING 10'-2"

INSIDE WIDTH 120"

COAL
19 TONS

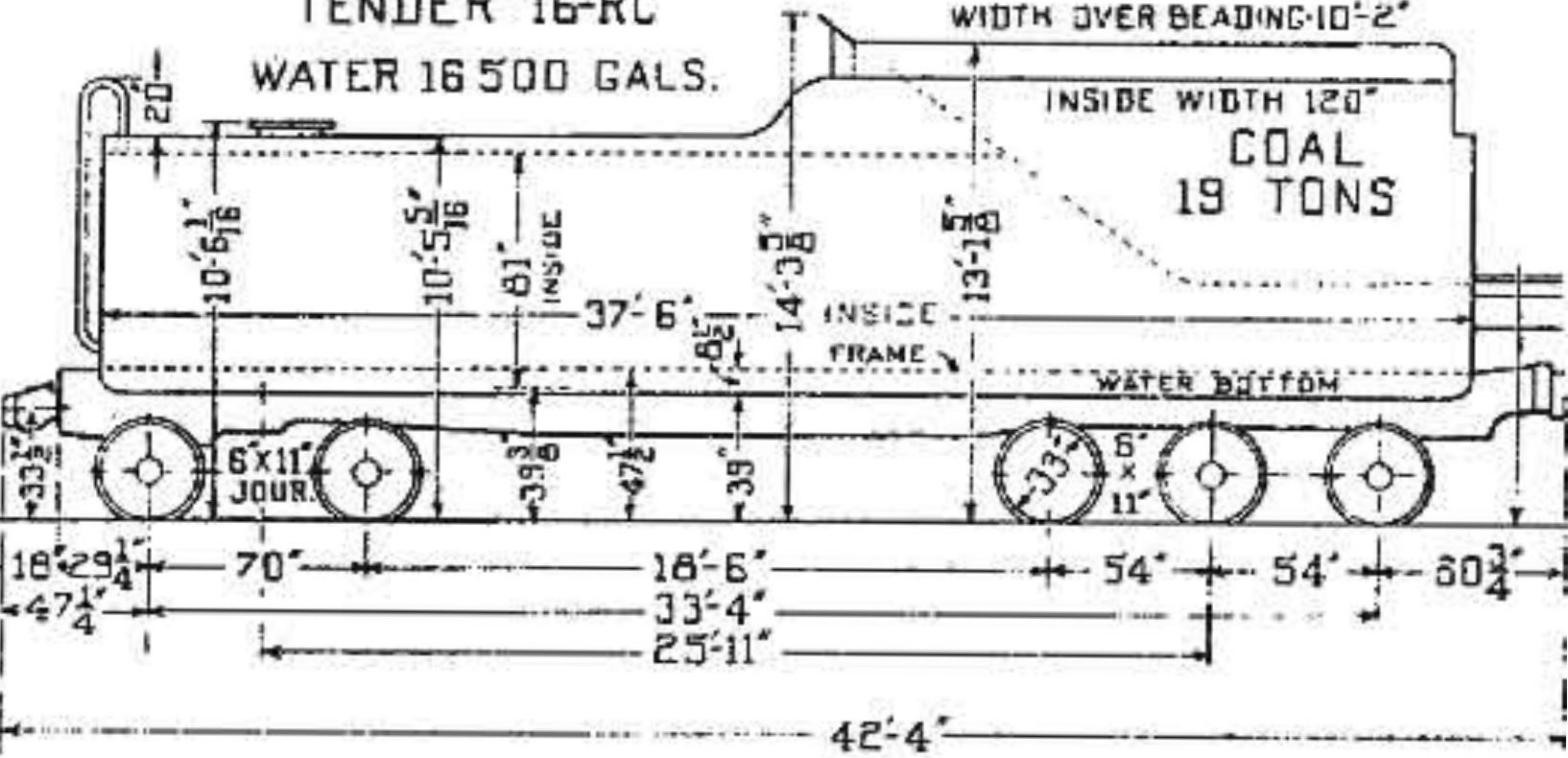

TENDER 21-RE

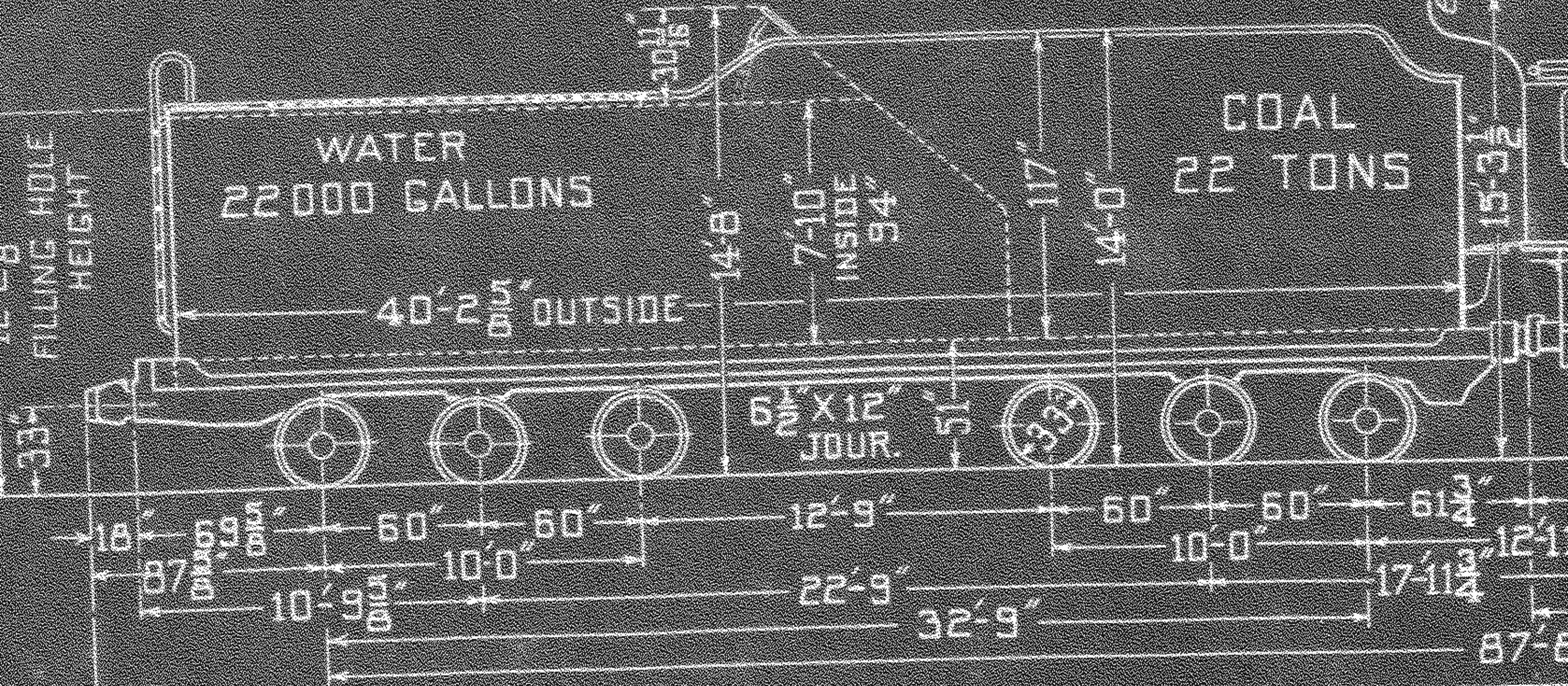

22-RA IS EXTRA TENDER BUILT IN 1934
 TENDER 22-RA

